

PRODUCT SPECIFICATION

28 & 29 Series Solid State Relays

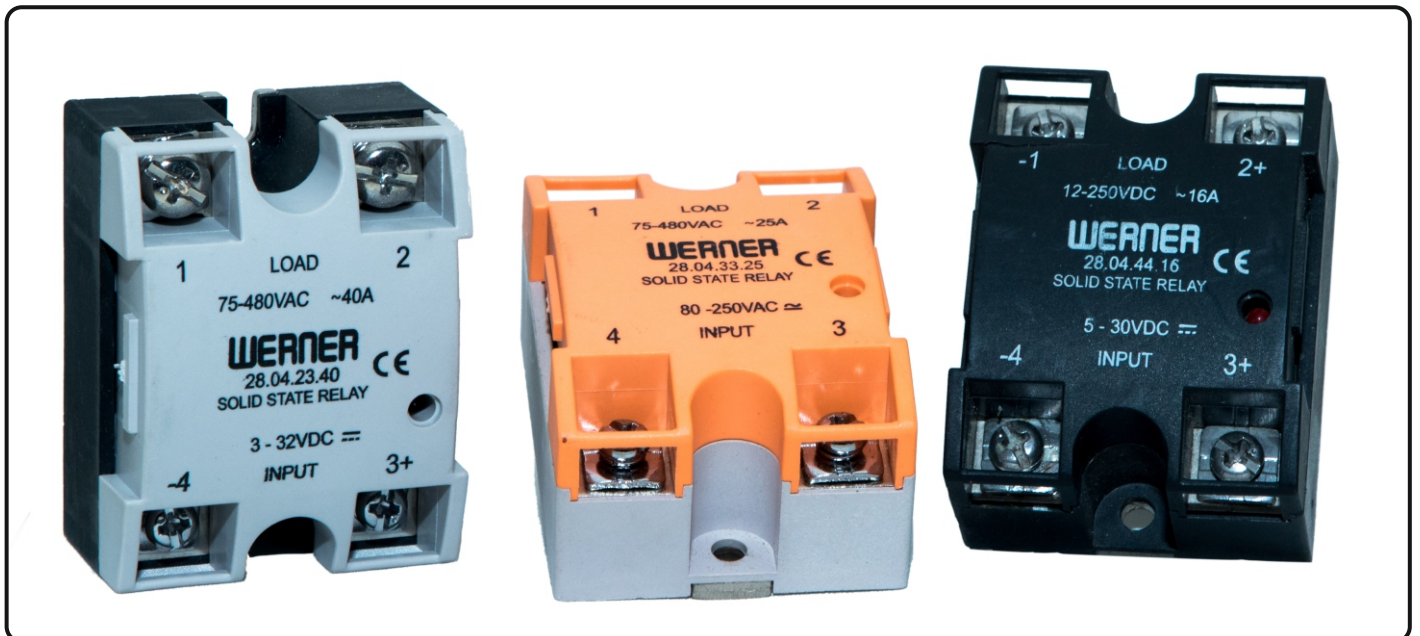

28 & 29 Series Solid State Relays



Technical Data	1
Model Number Selection - Panel Mounting Type	2
PCB Mountable	3
Solid State Relay	7
Model Number Structure - Relays	10
Thermal Derate Curve	11
One-touch Mounting Plate	12

28 & 29 Series Solid State Relays



Solid State Relay

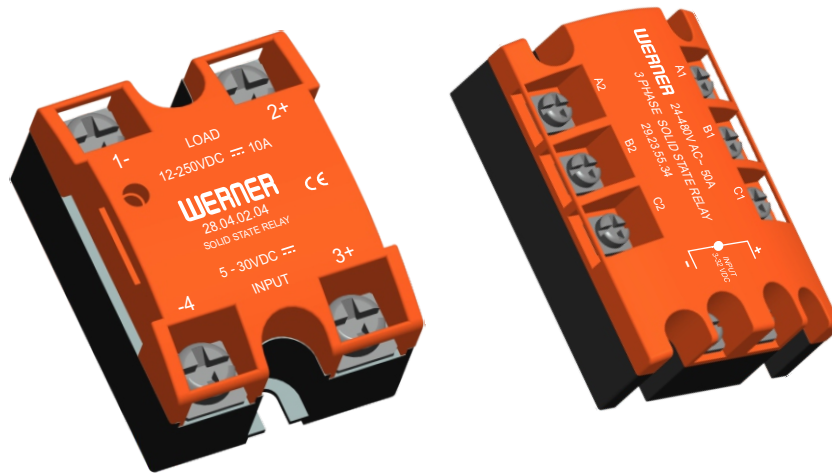

WERNER's 28 & 29 Series Solid State Relays are designed for the ultimate applications in the world of LV-Switchgear building where electronic switching is required, if it comes to control switch tensions of up to 480V (DC) and handling of current of up to 100 Amperes at the same time. They come in 4 different mounting types, from which 3 are even cleverly designs for direct mounting on your PC boards.

Features Overview

- Unique designed heat sinks save space and provide maximum heat dissipation
- Built-in snubber circuit protects against external surges with high efficiency
- All AC models come with built in '0' Crossing circuit as a standard feature
- All models available for use with 50 Hz and 60 Hz cycles
- Use 29 Series for 2 & 3 Phase Output
- Built in Reverse voltage protection

Highlights

- Find the right model for any load current between 2 and 100 Amperes
- Providing much higher operation frequency than mechanical relays
- Choose between AC and DC as the control Voltage for all models
- Highly extended lifetime by means of no moving parts
- Operation Indicators visualize the operational state
- All Solid State Relays are fully sealed type

28 & 29 Series Solid State Relays by WERNER are made for contact free switching without any moving parts and provide as such tremendous lifetime without any maintenance needed in a totally sealed housing, protecting them from all kinds of hazardous environmental influences- and all this comes combined in a very space saving compact design.

28 & 29 Series Solid State Relays



Features:

Wide Lineup of General-purpose Solid State Relays with Applicable Loads of 2 to 100 A

- Finger protective guard for greater safety.
- LED indicator enables monitoring operation.
- All models feature the same compact dimensions to provide a uniform mounting pitch.
- Built-in varistor effectively absorbs external surges.



Approvals

Approbations and Declaration of conformity

CE



Model Number Selection - Panel Mounting Type

Image	Mount	Control Voltage	Load Current	Load Voltage	Model No.
	04	3-32 VDC	2A	24-240VAC	28.04.22.02
	04	3-32 VDC	5A	24-240VAC	28.04.22.05
	04	3-32 VDC	10A	24-240VAC	28.04.22.10
	04	3-32 VDC	20A	24-240VAC	28.04.22.20
	04	3-32 VDC	25A	24-240VAC	28.04.22.25
	04	3-32 VDC	30A	24-240VAC	28.04.22.30
	04	3-32 VDC	40A	24-240VAC	28.04.22.40
	04	3-32 VDC	50A	24-240VAC	28.04.22.50
	04	3-32 VDC	60A	24-240VAC	28.04.22.60
	04	3-32 VDC	70A	24-240VAC	28.04.22.70
	04	3-32 VDC	75A	24-240VAC	28.04.22.75
	04	3-32 VDC	80A	24-240VAC	28.04.22.80
	04	3-32 VDC	90A	24-240VAC	28.04.22.90
	04	3-32 VDC	100A	24-240VAC	28.04.22.100

28 & 29 Series Solid State Relays



Model Number Selection - Panel Mounting Type



Image	Mount	Control Voltage	Load Current	Load Voltage	Model No.
	04	80-250 VAC	2A	24-240VAC	28.04.32.02
	04	80-250 VAC	5A	24-240VAC	28.04.32.05
	04	80-250 VAC	10A	24-240VAC	28.04.32.10
	04	80-250 VAC	20A	24-240VAC	28.04.32.20
	04	80-250 VAC	25A	24-240VAC	28.04.32.25
	04	80-250 VAC	30A	24-240VAC	28.04.32.30
	04	80-250 VAC	40A	24-240VAC	28.04.32.40
	04	80-250 VAC	50A	24-240VAC	28.04.32.50
	04	80-250 VAC	60A	24-240VAC	28.04.32.60
	04	80-250 VAC	70A	24-240VAC	28.04.32.70
	04	80-250 VAC	75A	24-240VAC	28.04.32.75
	04	80-250 VAC	80A	24-240VAC	28.04.32.80
	04	80-250 VAC	90A	24-240VAC	28.04.32.90
	04	80-250 VAC	100A	24-240VAC	28.04.32.100

	04	5-30 VDC	2A	12-250VDC	28.04.44.02
	04	5-30 VDC	5A	12-250VDC	28.04.44.05
	04	5-30 VDC	10A	12-250VDC	28.04.44.10
	04	5-30 VDC	20A	12-250VDC	28.04.44.20
	04	5-30 VDC	25A	12-250VDC	28.04.44.25
	04	5-30 VDC	30A	12-250VDC	28.04.44.30
	04	5-30 VDC	40A	12-250VDC	28.04.44.40
	04	5-30 VDC	50A	12-250VDC	28.04.44.50
	04	5-30 VDC	60A	12-250VDC	28.04.44.60
	04	5-30 VDC	70A	12-250VDC	28.04.44.70
	04	5-30 VDC	75A	12-250VDC	28.04.44.75
	04	5-30 VDC	80A	12-250VDC	28.04.44.80
	04	5-30 VDC	90A	12-250VDC	28.04.44.90
	04	5-30 VDC	100A	12-250VDC	28.04.44.100

28 & 29 Series Solid State Relays



PCB Mountable

Appearances	 TYPE 1	 TYPE 2	 TYPE 3
-------------	---	--	---

Model No.	28.01.12.02	28.02.12.02	28.03.23.05
Guarantee close voltage	1 VDC		
Guarantee open voltage	3 VDC		
Load mini current	0.05A		
Control voltage	5 VDC		3-32 VDC
Control current	6-25 mA		4-20 mA
Reverse voltage	-		32VDC
Breakover voltage	≤1VAC		≤1.6 VAC
Output leakage current	≤1 mA		≤5 mA
Load voltage	24-280VAC		24-440VAC
Load max current	2A		5A
Frequency range	50-60 Hz		
Operating temperature	-20-70°C		
Load current safety factor	resistive load 50-60% Inductive load 30-40%		
Medium withstand voltage	2500 VAC		
Insulating resistance	100MΩ		
Switching time	10ms		

Dimensions

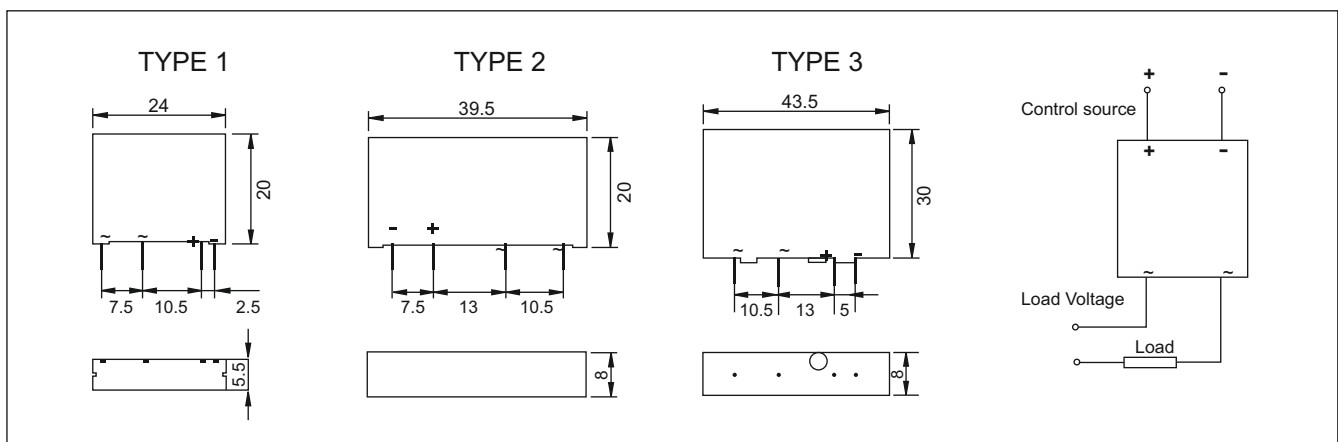

28 & 29 Series Solid State Relays

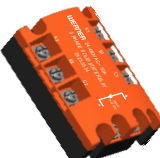

Model Number Selection - Panel Mounting Type

Image	Mount	Control Voltage	Load Current	Load Voltage	Model No.
	04	3-32 VDC	10A	75-480VAC	29.04.11.10
	04	3-32 VDC	20A	75-480VAC	29.04.11.20
	04	3-32 VDC	25A	75-480VAC	29.04.11.25
	04	3-32 VDC	30A	75-480VAC	29.04.11.30
	04	3-32 VDC	40A	75-480VAC	29.04.11.40
	04	3-32 VDC	50A	75-480VAC	29.04.11.50
	04	3-32 VDC	60A	75-480VAC	29.04.11.60
	04	3-32 VDC	70A	75-480VAC	29.04.11.70
	04	3-32 VDC	80A	75-480VAC	29.04.11.80
	04	3-32 VDC	90A	75-480VAC	29.04.11.90
	04	3-32 VDC	100A	75-480VAC	29.04.11.100
	04	80-250 VAC	10A	75-480VAC	29.04.21.10
	04	80-250 VAC	20A	75-480VAC	29.04.21.20
	04	80-250 VAC	25A	75-480VAC	29.04.21.25
	04	80-250 VAC	30A	75-480VAC	29.04.21.30
	04	80-250 VAC	40A	75-480VAC	29.04.21.40
	04	80-250 VAC	50A	75-480VAC	29.04.21.50
	04	80-250 VAC	60A	75-480VAC	29.04.21.60
	04	80-250 VAC	70A	75-480VAC	29.04.21.70
	04	80-250 VAC	80A	75-480VAC	29.04.21.80
	04	80-250 VAC	90A	75-480VAC	29.04.21.90
	04	80-250 VAC	100A	75-480VAC	29.04.21.100

28 & 29 Series Solid State Relays



Type 4

Appearances



Model No.

28.04.2* **

28.04.3* **

Guarantee close voltage	1 VDC	30 VAC
Guarantee open voltage	3 VDC	80 VAC
Load mini current	0.05A	
Control voltage	3-32 VDC	80-250 VAC
Control current	4-20 mA	3-20 mA
Reverse voltage	32 VDC	NO
Breakover voltage	≤ 1.6 VAC	
Output leakage current	≤ 5 mA	
Load voltage	24-240VAC 75-480VAC	
Load max current	10A, 20a, 25A, 30A, 40A, 50A, 60A, 70A, 75A, 80A, 90A, 100A	
Frequency range	50-60 Hz	
Operating temperature	-20-70°C	
Load current safty factor	resistive load 50-60% Inductive load 30-40%	
Medium withstand voltage	2500 VAC	
Insulating resistance	100MΩ	
Switching time	10ms	

Dimensions

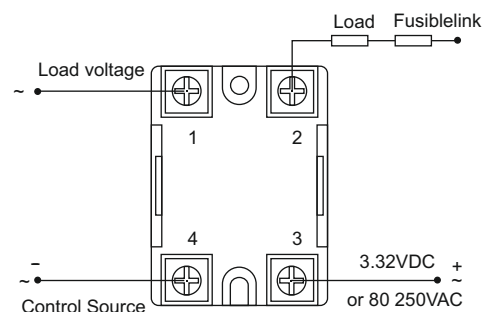
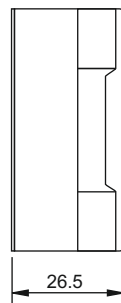
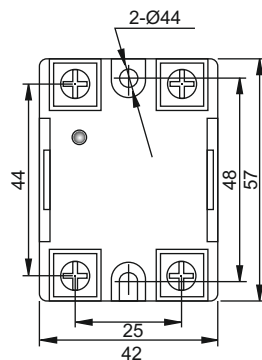

Note: ** Stands for amps

28 & 29 Series Solid State Relays



Type 4

Appearances



Model No.

28.04.44.**

Guarantee close voltage	1 VDC
Guarantee open voltage	3 VDC
Load mini current	0.05A
Control voltage	5-30 VDC
Control current	4-20 mA
Reverse voltage	32 VDC
Breakover voltage	≤ 1.6 VAC
Output leakage current	≤ 5 mA
Load voltage	12-250VDC
Load max current	10A, 20a, 25A, 30A, 40A, 50A, 60A, 70A, 75A, 80A, 90A, 100A
Frequency range	50-60 Hz
Operating temperature	-20-70°C
Load current safty factor	resistive load 50-60% Inductive load 30-40%
Medium withstand voltage	2500 VAC
Insulating resistance	100MΩ
Switching time	10ms

Dimensions

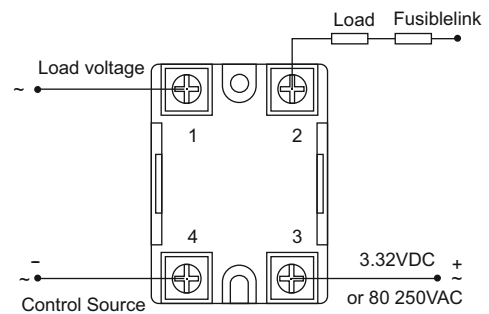
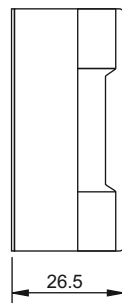
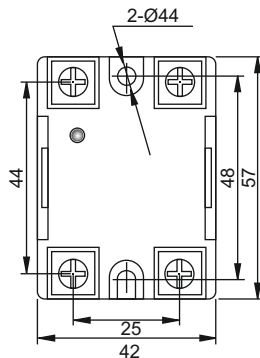

Note: ** Stands for amps

28 & 29 Series Solid State Relays



Solid State Relay



Model No.	29.04.21.90	29.04.21.150	29.04.21.300	29.04.21.400
Gurantee close voltage	1 VDC			
Gurantee open voltage	3 VDC			
Load mini current	0.05A			
Control voltage	3-32 VDC			
Control current	6-25 mA			
Reverse voltage	32 VDC			
Breakover voltage	≤ 1.6 VAC			
Output leakage current	≤8 mA			
Load voltage	75-480VAC			
Load max current	60A-90A	100A-150A	160A-300A	300A-400A
Frequency range	50-60 Hz			
Operating temperature	-20-70°C			
Load current safty factor	resistive load 50-60% Inductive load 30-40%			
Medium withstand voltage	2500 VAC			
Insulating resistance	100MΩ			
Switching time	10ms			

Dimensions

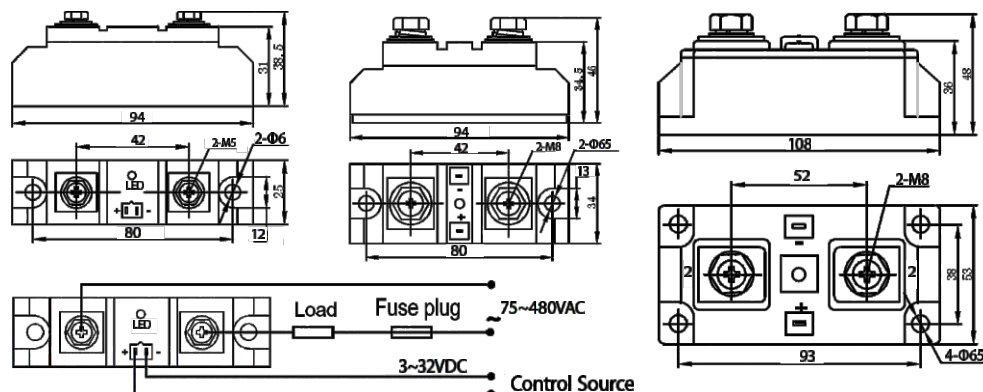

28 & 29 Series Solid State Relays



Solid State Relay

Appearances



Model No.

29.04.11.**

29.04.21.**

Guarantee close voltage	1 VDC	30 VAC
Guarantee open voltage	3 VDC	80 VAC
Load mini current	0.05A	
Control voltage	3-32 VDC	80-250 VAC
Control current	10-30 mA	8-30 mA
Reverse voltage	32 VDC	NO
Breakover voltage	≤ 1.6 VAC	
Output leakage current	≤5 mA	
Load voltage	24-480VAC	
Load max current	10A, 20A, 25A, 30A, 40A, 50A, 60A, 70A, 80A, 90A, 100A	
Frequency range	50-60 Hz	
Operating temperature	-20-70°C	
Load current safty factor	resistive load 50-60% Inductive load 30-40%	
Medium withstand voltage	2500 VAC	
Insulating resistance	100MΩ	
Switching time	10ms	

Dimensions

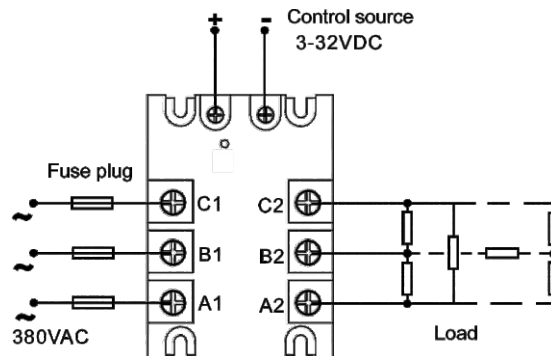
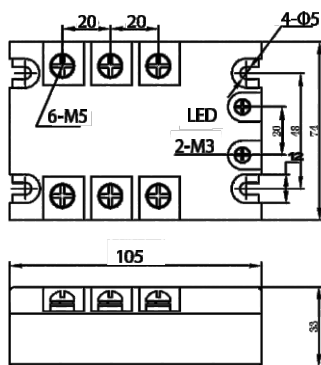

Note: ** Stands for amps

28 & 29 Series Solid State Relays



Model Number Structure - Relays



28.04.22.05

Series	
28 Series Solid State Relays	

Mounting Type	
01	Type 1
02	Type 2
03	Type 3
04	Type 4

Control Voltage	
2	3-32 VDC
3	80-250 VAC
4	5-30 VDC

Load Current	
02	2A
05	5A
10	10A
20	20A
25	25A
30	30A
40	40A
50	50A
60	60A
70	70A
75	75A
80	80A
90	90A
100	100A

Load Voltage	
2	24-240VAC
3	75-480VAC
4	12-250VDC
5	12-400VDC

28 & 29 Series Solid State Relays



Model Number Structure - Relays



29.04.21.90

Series	
29 Series Solid State Relays	

Mounting Type	
01	Type 1
02	Type 2
03	Type 3
04	Type 4
05	Type 5

Control Voltage	
1	3-32 VDC
2	80-250 VAC

Load Current	
10	10A
20	20A
25	25A
30	30A
40	40A
50	50A
60	60A
70	70A
80	80A
90	90A
100	100A

Load Voltage	
1	24-480VAC

28 & 29 Series Solid State Relays



Thermal Derate Curve

DERATE CURVES
29 Series IP20 25A

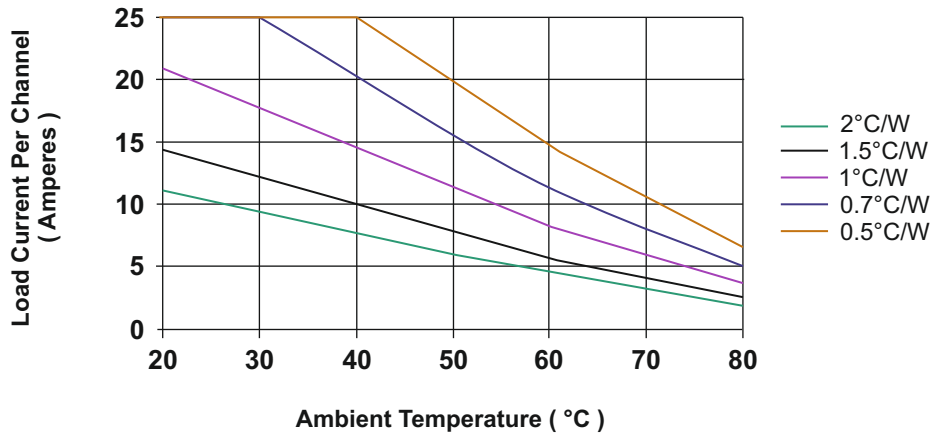

DERATE CURVES
29 Series IP20 60A

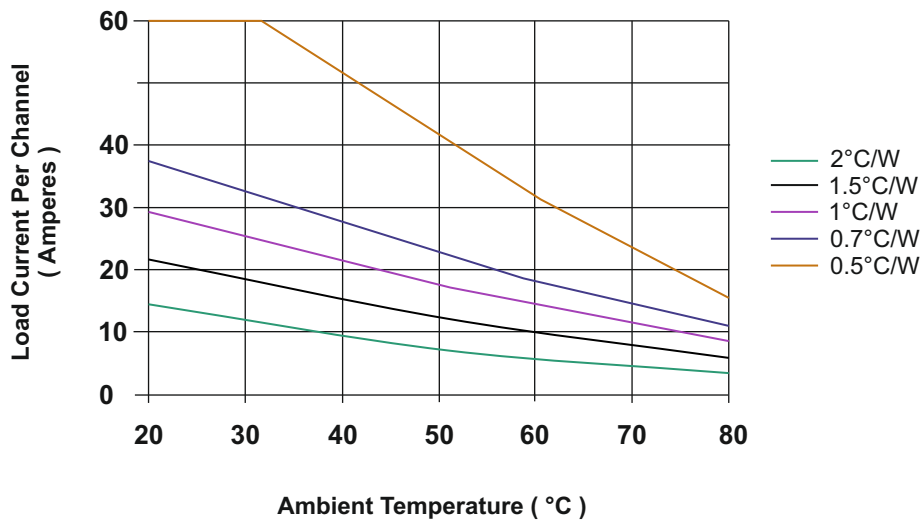

28 & 29 Series Solid State Relays



One-touch Mounting Plate

The One-touch Mounting Plate is used to mount the SSR to a DIN Track.

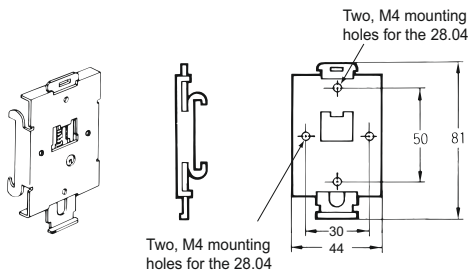

To mount the Relay to DIN Track, first mount it to the One-touch Mounting Plate and then attach it to the DIN Track as shown in the diagram.

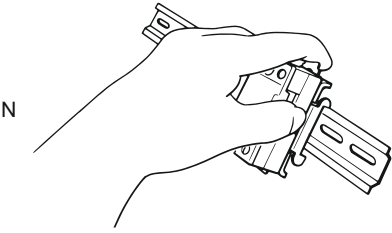

To remove the Relay from the DIN Track, pull down on the tab with a screwdriver in the direction of the arrow.

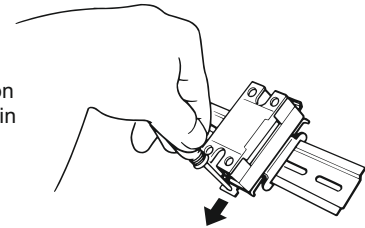

- When a Relay is mounted to DIN Track, use it within the rating for a Relay without a heat sink.

28 & 29 Series Solid State Relays



Terms And Conditions

Please read this catalog before purchasing any products. Please consult your *WERNER* representative for any clarifications or comments.

Application Considerations

WERNER shall not be responsible for conformity with any regulations, codes or standards that apply to use of the products. *WERNER* shall provide applicable third party certification documents identifying ratings and limitations of use that apply to the products in case of the customer's request.

Prevent use the products for an application involving risk to life or property. Be sure that the *WERNER*'s products are properly rated and installed for the overall system or equipment.

WERNER shall not be responsible for the user's programming of a programmable products.

Warranty

WERNER's warranty represents that the products are free from defects in materials and workmanship for a period of one year.

WERNER shall not be responsible for any special loss of profit, commercial loss, indirect or consequential damages relevant to products.

WERNER shall not be responsible for repair, warranty or any claims regarding the products unless *WERNER*'s Analysis conform that the products were properly stored, installed, handled, maintained and not a the results from accident, insufficient, abuse, misuse, natural disaster, improper installation excessive electrical supply, environmental conditions or abnormal mechanical.

Disclaimers

WERNER shall practice to change type/model numbers when published ratings or features are changed, however some specifications of the products may be changed without any notice.

When in doubt, please consult with your *WERNER* representative to confirm actual specifications of products.

WERNER shall change product specifications and accessories at any time based on improvements and other reasons.

The information in this catalog has been carefully checked. However, *WERNER* take no responsibilities for clerical, typographical or proofreading errors.

WERNER
Electric | Inventing Innovation

Product specifications are subject to change without notice.

Thank you for choosing *WERNER* products.

WERNER

Inventing Innovation...

Werner Electric Pvt. Ltd.,

Plot No. 166, Hebbal Industrial Area, Mysore - 570016, India

Tel: +91-9686321242 • E: info@in.wernerelektrik.com